

ballad lounge



ballad lounge

product information

The office is no longer just about work but about a lifestyle and Ballad combines form and function into a lounge chair that will be a timeless addition to any space. Designed for Studio TK by Patrick Norguet, the Ballad lounge chair is not just about aesthetics and is centered around user comfort. "The chair needs to be authentic; it needs a balance between comfort and design. We don't sell a piece of art, we sell a comfortable chair."

The lounge chair is available in a traditional low back or in a high back option for more privacy and combined with a pedestal style disc; four-star base with swivel; or a unique wood four-star base with swivel. With an extensive list of textiles to choose from, the seat and back can be finished in complementary or contrasting fabrics for more customizability.

Designer Patrick Norguet
Typology Lounge Seating

Collection Studio TK
Year 2025

Collection



Fabrics & Finishes

Upholstery

Can be finished in fabrics available from Luum, Maharam, and Kvadrat; COM/COL

Metal Frame Finishes

Fundamental and Fashion powdercoat finishes available.

Wood Frame Finishes

Basque White Oak, Natural Oak, Sierra, Cocoa Brown, Truffle

Dimensions

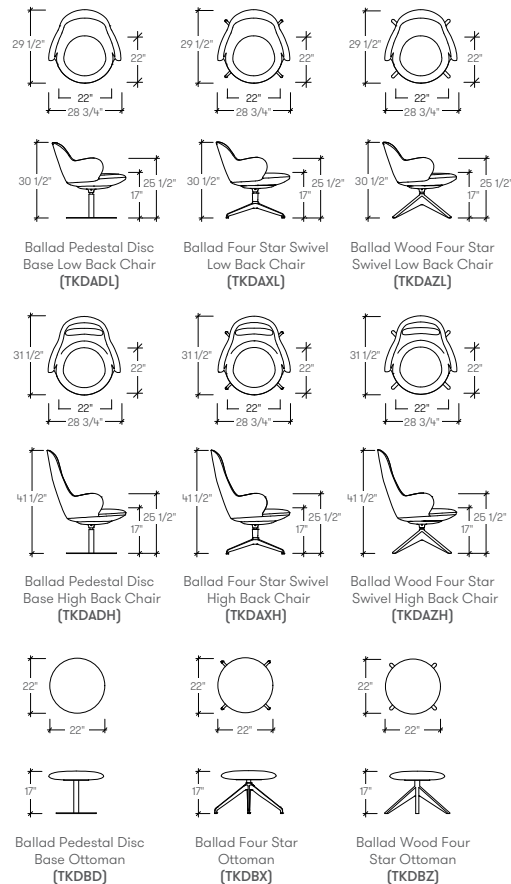

Studio TK

3940 US 70 Business Hwy, West
 Clayton, North Carolina 27520, USA
 Tel: 855.941.0262 / Fax: 919.464.2927
 www.studiotk.com

®, TM Trademarks of teknon corporation and/or its subsidiaries or licensed to it. Patents may be pending. Some products may not be available in all markets. Contact your local Studio TK representative for availability. CAN/US/INT 05/25 © Teknon 2025 Printed in Canada



ballad plastic chair



ballad plastic chair

product information

Choice is central to Ballad plastic seating with easy to clean polypropylene seat shell in five durable finishes and hybrid options of an upholstered seat, or seat and back combination for added comfort and finish options. Designed for Studio TK by Patrick Norguet, Ballad is "pure, a simple form with nice details and a little character." The result is something special, a complete line of seating that provides good comfort; good value; good quality; and of course, good design.

In addition to multiple plastic and upholstery options, Ballad chairs are available with or without arms in six base options finished in a durable powder paint or rich wood tone.

Designer
Patrick Norguet

Typology
Guest Seating

Collection
Studio TK

Year
2025

Collection



Fabrics & Finishes

Upholstery

Seat & back can be finished in fabrics available from Luum, Maharam, and Kvadrat; COM/COL

Plastic

Principal and Expression Plastics

Metal Frame Finishes

Fundamental and Fashion powdercoat finishes available.

Wood Frame Finishes

Basque White Oak, Natural Oak, Sierra, Cocoa Brown, Truffle

Dimensions

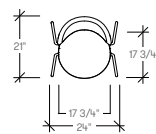

Ballad Plastic Armless Chair,
Four Leg Base
(TKDNPA)

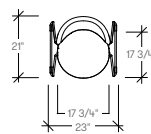

Ballad Plastic Armless Chair,
Sled Base
(TKDNPO)

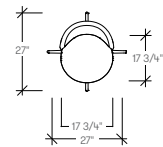

Ballad Plastic Armless Chair,
Four Star Swivel Base
(TKDNPX)

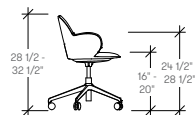
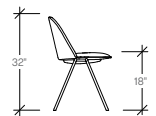

Ballad Plastic Armchair,
Five Star Task Base
(TKDJPY)

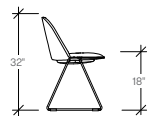

Ballad Plastic Armchair,
Wood Four Leg Base
(TKDJPW)

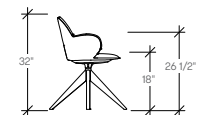
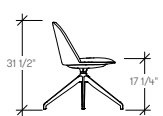

Ballad Plastic Armchair,
Wood Four Star Swivel Base
(TKDJPZ)

Studio TK

3940 US 70 Business Hwy, West
Clayton, North Carolina 27520, USA
Tel: 855.941.0262 / Fax: 919.464.2927
www.studiotk.com

®,™ Trademarks of teknon corporation and/or its subsidiaries or licensed to it. Patents may be pending. Some products may not be available in all markets. Contact your local Studio TK representative for availability. CAN/US/INT 05/25 © Teknon 2025 Printed in Canada

ballad upholstered chair



ballad upholstered chair

product information

Designed for Studio TK by Patrick Norguet, Ballad is "pure, a simple form with nice details and a little character." But a great chair is more than just design and the form is secondary to the invitation of comfort. Comfort was at the forefront in the design process for Ballad and the result is something special, a complete line of seating that provides good comfort; good value; good quality; and of course, good design.

Optionality is fundamental to Ballad seating. Chairs are available with or without arms in six base options that are finished in a durable powder paint or rich wood tone. Fully or partially upholstered Ballad has the option of matching or contrasting textiles on the seat and back.

Designer
Patrick Norguet

Typology
Guest Seating

Collection
Studio TK

Year
2025

Collection



Fabrics & Finishes

Upholstery

Can be finished in fabrics available from Luum, Maharam, and Kvadrat; COM/COL

Metal Frame Finishes

Fundamental and Fashion powdercoat finishes available.

Wood Frame Finishes

Basque White Oak, Natural Oak, Sierra, Cocoa Brown, Truffle

Dimensions

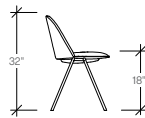
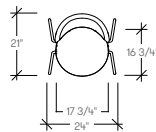

Ballad Upholstered Armless Chair, Four Leg Base (TKDMA)

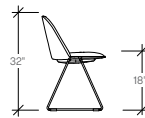
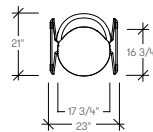

Ballad Upholstered Armless Chair, Sled Base (TKDMQ)

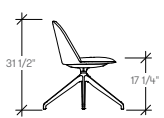
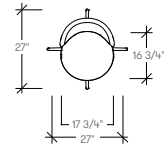

Ballad Upholstered Armless Chair, Four Star Swivel Base (TKDMX)

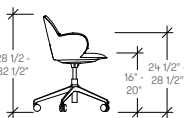
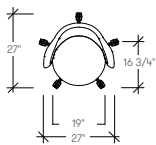

Ballad Upholstered Armchair, Five Star Task Base (TKDHY)

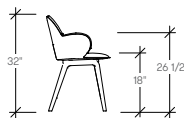
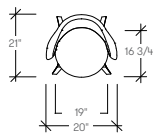

Ballad Upholstered Armchair, Wood Four Leg Base (TKDHW)

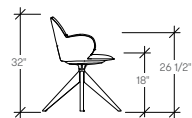
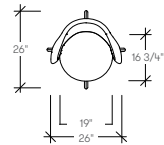

Ballad Upholstered Armchair, Wood Four Star Swivel Base (TKDHZ)

Studio TK

3940 US 70 Business Hwy, West
Clayton, North Carolina 27520, USA
Tel: 855.941.0262 / Fax: 919.464.2927
www.studiotk.com

®, TM Trademarks of teknon corporation and/or its subsidiaries or licensed to it. Patents may be pending. Some products may not be available in all markets. Contact your local Studio TK representative for availability.
CAN/US/INT 05/25 © Teknon 2025 Printed in Canada

ballad upholstered stool



ballad upholstered stool

renseignements sur le produit

Conçue pour Studio TK par Patrick Norguet, Ballad est « pure, une forme simple avec de jolis détails et un peu de caractère ». Le confort était au cœur du design de Ballad, et le résultat est remarquable : une gamme complète de tabourets et de fauteuils complémentaires qui offrent un excellent confort, un excellent rapport qualité-prix, une excellente qualité et, bien sûr, un excellent design.

Les tabourets Ballad sont offerts sans appuie-bras, avec deux bases à la finition en thermolaquage durable. Entièrement recouvert, le mobilier Ballad propose des tissus complémentaires ou contrastants pour le siège et le dossier.

Concepteur
Patrick Norguet

Classification
Tabouret

Collection
Studio TK

Année
2025

Collection



Tissus et finitions

Recouvrement

Tissus de Luum, Maharam et Kvadrat pour le siège et le dossier; COM/COL

Finitions du cadre de métal

Thermolaquages Fundamental et Fashion

Dimensions

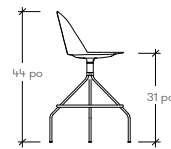
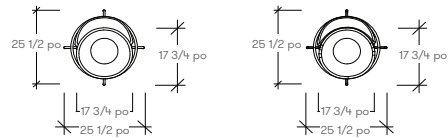

Tabouret Ballad recouvert de tissu sans appuie-bras, base cruciforme pivotante, siège hauteur bar (TKDDXH1)

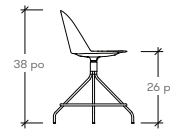

Tabouret Ballad recouvert de tissu sans appuie-bras, base cruciforme pivotante, siège hauteur comptoir (TKDDXH2)

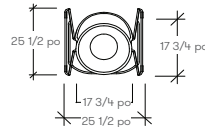

Tabouret Ballad recouvert de tissu sans appuie-bras, piètement traîneau, siège hauteur bar (TKDDQH1)

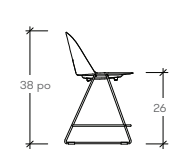
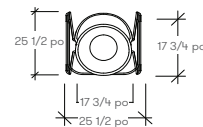

Tabouret Ballad recouvert de tissu sans appuie-bras, piètement traîneau, siège hauteur comptoir (TKDDQH2)

Studio TK

3940 US 70 Business Hwy West
Clayton, North Carolina 27520, États-Unis
Tél. : 1.855.941.0262/Télééc. : 919.464.2927
www.studiotk.com

Les marques suivies de TM et ^{MC} sont des marques de commerce de Teknion ou de ses filiales, ou utilisées sous licence par celles-ci. Certains brevets peuvent être en instance. Les produits ne sont pas tous ouverts dans l'ensemble des marchés. Communiquez avec votre représentant Studio TK à ce sujet.
FR 05-25 © Teknion, 2025. Imprimé au Canada.

ballad plastic stool



ballad plastic stool

product information

Designed for Studio TK by Patrick Norguet, Ballad is "pure, a simple form with nice details and a little character." Stools extend the line upward with a counter or bar height seat in an easy to clean polypropylene seat shell in five durable finishes and hybrid options of an upholstered seat, or seat and back combination for added comfort and finish options.

In addition to multiple plastic and upholstery options, Ballad stools are available in two base styles finished in a durable powder paint.

Collection



Designer Patrick Norguet	Typology Stool
Collection Studio TK	Year 2025

Fabrics & Finishes

Upholstery

Seat & back can be finished in fabrics available from Luum, Maharam, and Kvadrat; COM/COL

Plastic

Principal and Expression Plastics

Metal Frame Finishes

Fundamental and Fashion powdercoat finishes available.

Dimensions

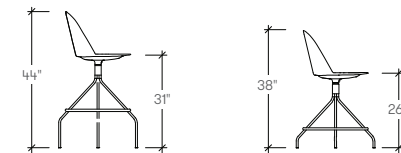
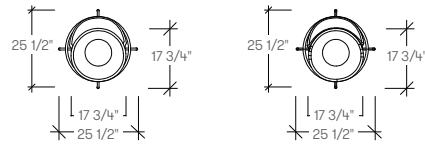

Ballad Armless Stool, Four Star Swivel, Bar Height (TKDEPXH1)

Ballad Armless Stool, Four Star Swivel, Counter Height (TKDEPXH2)

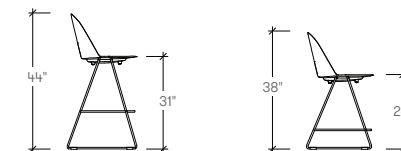
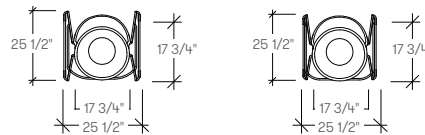

Ballad Armless Stool, Sled Base, Bar Height (TKDEPQH1)

Ballad Armless Stool, Sled Base, Counter Height (TKDEPQH2)

Studio TK

3940 US 70 Business Hwy, West
Clayton, North Carolina 27520, USA
Tel: 855.941.0262 / Fax: 919.464.2927
www.studiotk.com

®, TM Trademarks of teknon corporation and/or its subsidiaries or licensed to it. Patents may be pending. Some products may not be available in all markets. Contact your local Studio TK representative for availability.
CAN/US/INT 05/25 © Teknon 2025 Printed in Canada

