

Ceiling Scape

# Pantheon

Temple of Sound

A coffered ceiling scape sinks unwanted sounds. Recessed square panels, airy and ancient, add dimensionality. Open tile options offer flexibility, accommodating existing fixtures. With Pantheon, make any space an architectural, acoustic feat.



Image by Imperfect\*

# How To Specify

## Key Information

Pantheon can recess into your space in a variety of ways. Consider these questions as you design your layout.

If shop drawings are required for your project, please follow steps 1 - 7.

## Fast Track

If you're looking to expedite your project, this product is available as Turf Fast Track!

Using Fast Track, our standard lead time for shop drawings is eliminated allowing the project to move directly into production.

Please note, installation and seaming drawings are not included in this process.

Turf recommends 10-15% additional tiles to cover overage / attic stock.

## Pattern Direction

Pantheon projects that use Wood Grains, Wood Textures or any Travertine Stone Textures are not available for Fast Track. Turf's design team can help guide you through these use cases for pattern direction.

See "Grains & Textures Pattern Direction" page for more details.

**1**

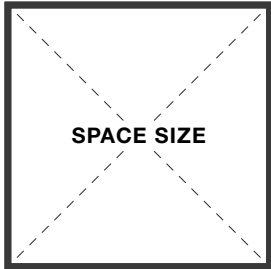

What are the dimensions of your space?

**2**

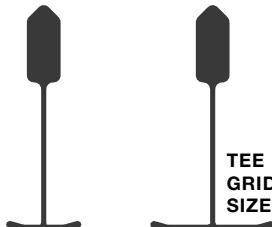

Are you using 9/16" or 15/16" tee grid?

PAGE 3

**3**

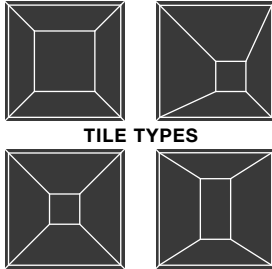

What tile types do you need?

PAGE 4-5

**4**

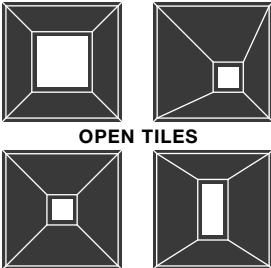

Do you need any open tiles?

PAGE 6

**5**

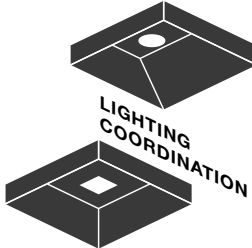

Does the project need tiles for lighting coordination?

PAGE 7

**6**

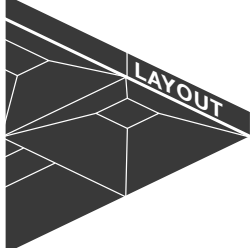

What is the proposed layout?

PAGE 8-9

**7**

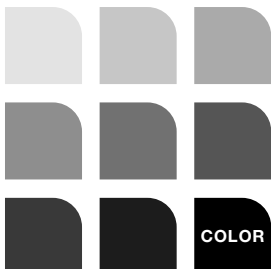

What is the color, grain or texture of tiles?

PAGE 13-16

**8**

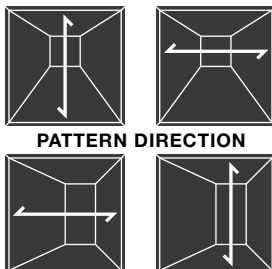

If using a wood grains, wood texture or any travertine stone texture, what's the pattern direction?

PAGE 10

**FAST TRACK**



1. What tee grid type are you using?
2. What tile types do you need?
3. Do you need any open tiles?
4. Will any tiles be precut for lighting?
5. What color or texture are the tiles?
6. How many tiles do you need?
7. Do you need additional infill tiles?
8. Do you want to include any extra product for overage or attic stock?

# Dimensions

Standard Size 24"L x 24"W x 3.65"D

Tile Types A, B, C, D, E, F

See "Tile Types" page for more details.

Tile Recess The center of Pantheon tiles are closed by default, but all tile types have an Open version.

See "Open Tiles" page for more details.

# Connection

9/16" or 15/16" Flat Tee Grid Friction Fit

# Color

9mm Palette Pantheon Tiles can be specified in any of our 9mm felt colors, grains or textures.

Pattern Direction Pantheon projects that use Wood Grains, Wood Textures or any Travertine Stone Textures must specify pattern direction.

See "Grains & Textures Pattern Direction" page for more details.

Color Match Have another color in mind? Our UV printing process can match almost any hue.

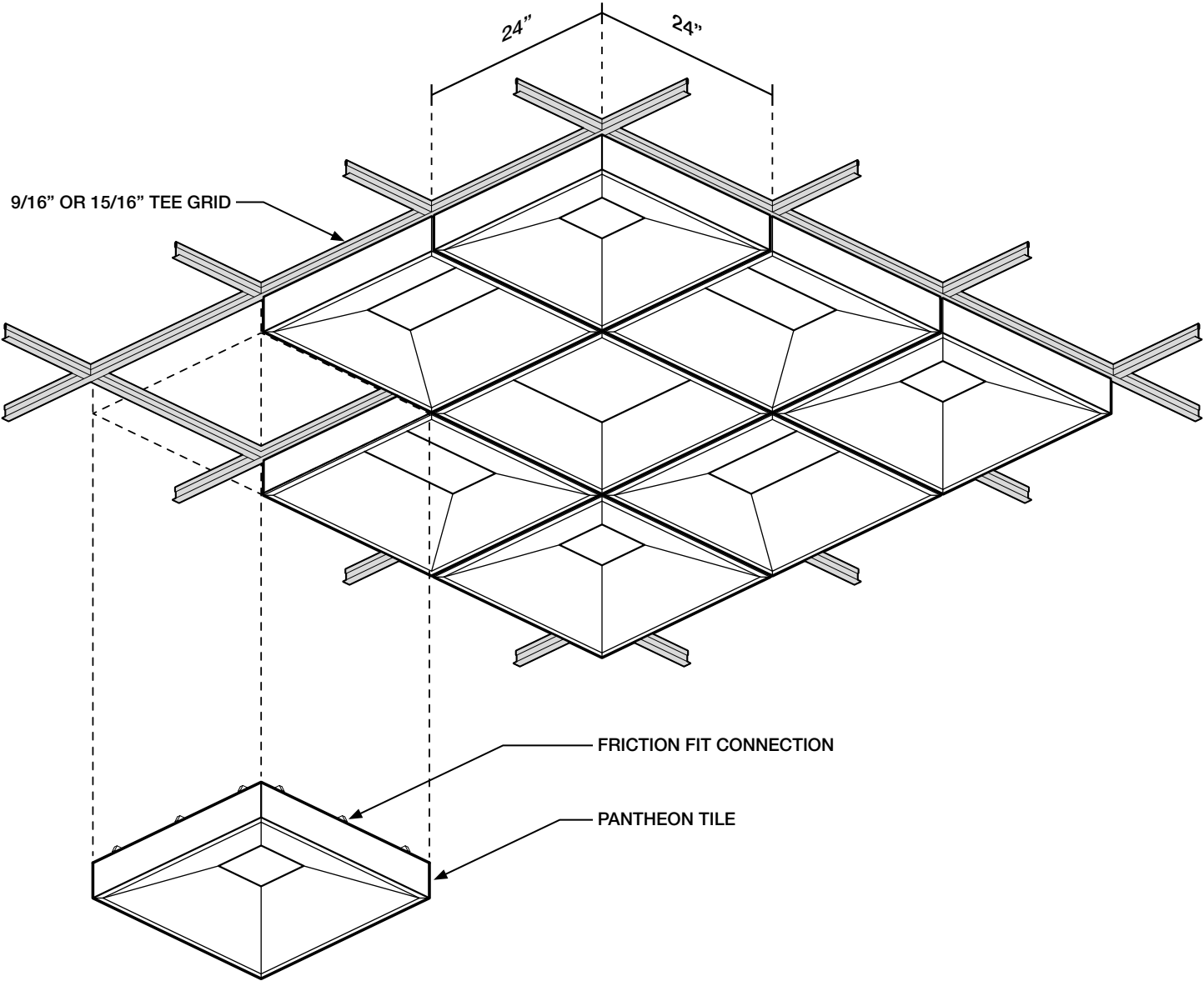

FRICITION FIT CONNECTION DETAIL

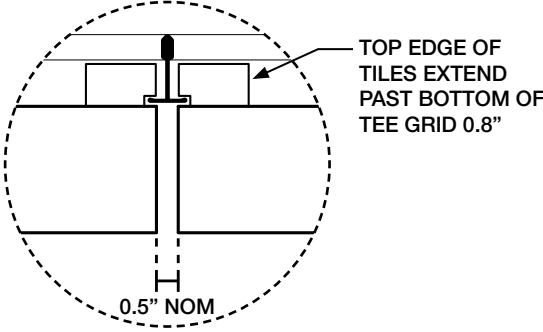

ALL DIMENSIONS NOMINAL UNLESS NOTED OTHERWISE



# Tile Types

**Design**

Pantheon tiles come in six standard types. Each profile has a unique size or position of recess. When coordinated together, the varying tiles create a dynamic ceiling.

**A Tiles**

Pantheon B & C tiles have a 12"L x 6"W rectangular recess that can be either centered or shifted.

**B & C Tiles**

Pantheon B & C tiles have a 12"L x 6"W rectangular recess, that can be either centered or shifted.

These tiles are perfect to use along the edge of an array, or to create a slimmer profile.

**PROFILE TYPES**

**PANTHEON A**

**PANTHEON B**

**PANTHEON C**

**PERSPECTIVE**

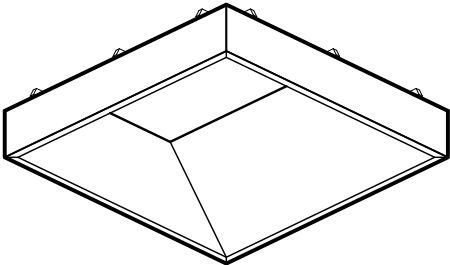
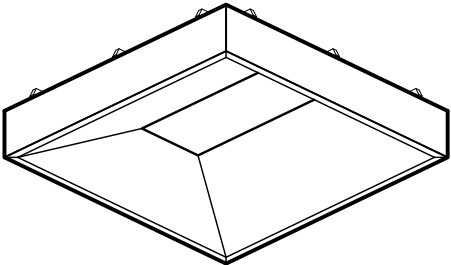
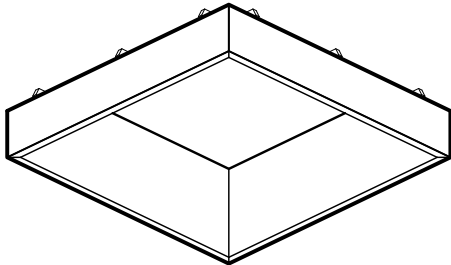

**PLAN VIEW**

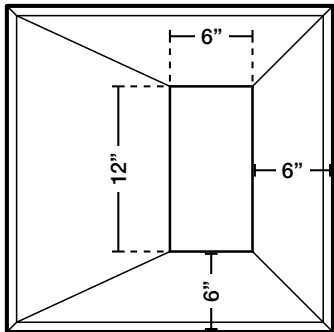
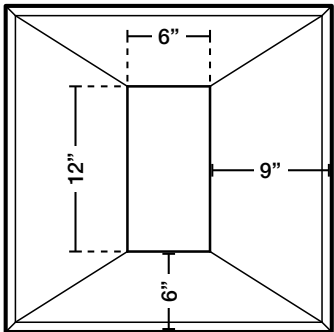
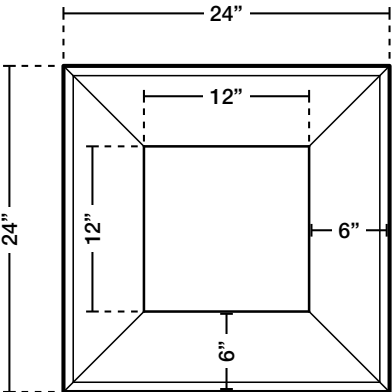

**TYPICAL ELEVATION**

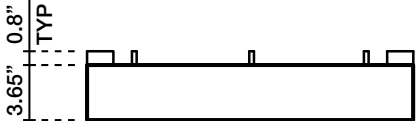

ALL DIMENSIONS NOMINAL UNLESS NOTED OTHERWISE



# Tile Types - Continued

D, E & F Tiles

Pantheon D, E, & F tiles have a 6" square recess that can be either centered or shifted in multiple directions.

These tiles are perfect to use as the corner to an array, or to create a consistent field.

Tile Layouts

See our "Typical Layouts" pages to help generate some ideas for tile type combinations.

Beyond this guide, all tile types can work together to create a layout tailored to your space.

## PROFILE TYPES

PANTHEON D

PANTHEON E

PANTHEON F

PERSPECTIVE

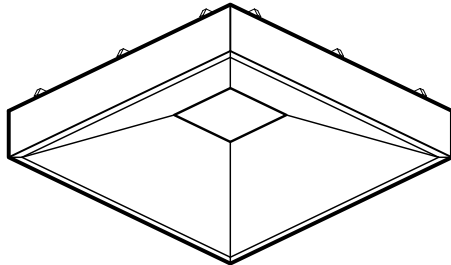
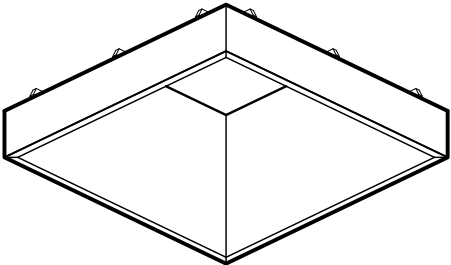
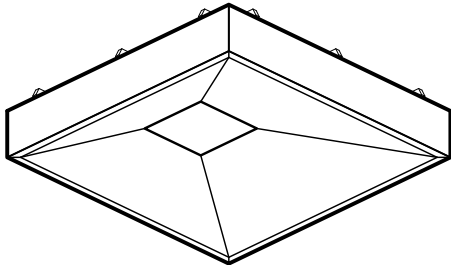

PLAN VIEW

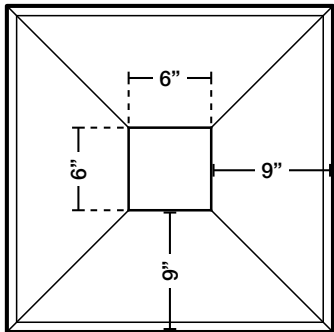
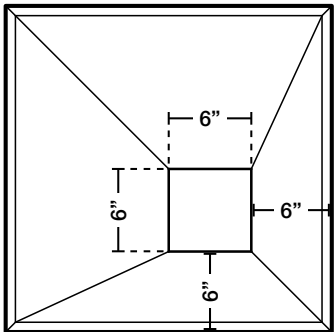
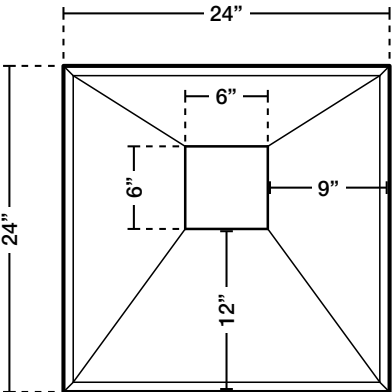

TYPICAL ELEVATION

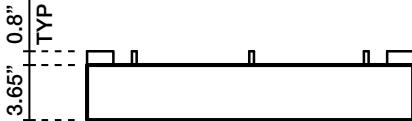

ALL DIMENSIONS NOMINAL UNLESS NOTED OTHERWISE



# Open Tiles

**Tile Flexibility** All six of the Pantheon tile types have an Open version where the recess is removed leaving the ceiling above visible.

**Ceiling and Equipment** Open tiles allow easy access to the ceiling above. These tiles offer maximum flexibility to drop lighting, sprinklers, and other ceiling devices.

**Recess Border** Open tiles will have a 1" border along the recess for tile rigidity.  
  
See the "Open Tile Detail" drawing at the bottom of this page for more information.

**Tile Types Compatibility** Please note: all tile types are available with an opening. The drawings only show a handful of examples.

## OPEN PROFILE TYPE EXAMPLES

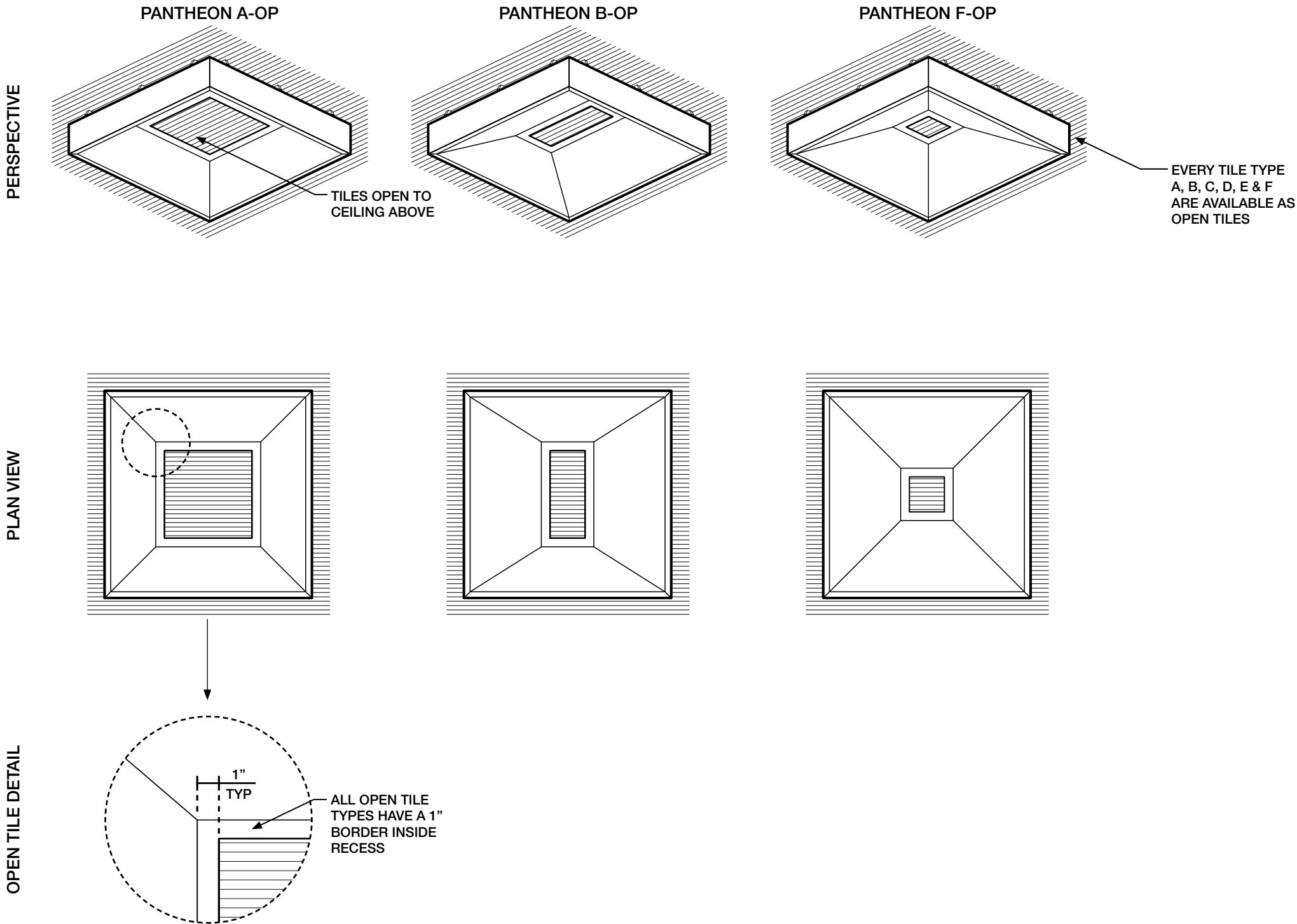

ALL DIMENSIONS NOMINAL UNLESS NOTED OTHERWISE



# Lighting Integration

**Design** Turf offers multiple precut holes that are designed to work with fixtures by USAI.

**Tile Types Compatibility** All Pantheon tile types are available with all fixture options below. The drawings only show a handful of examples.

Please note: the precut hole is centered on the recessed portion of each tile which is not necessarily the center of the overall tile.

**USAI Fixtures**  
 BeveLED Mini® for Turf - 3" Round  
 BeveLED® 2.2 for Turf - 4.5" Round  
 BeveLED Mini® for Turf - 3" Square  
 BeveLED® 2.2 for Turf - 4.5" Square

**USAI Lighting**

For more information visit [www.usalighting.com/turf-design](http://www.usalighting.com/turf-design)

**Coordination** Tiles have precut square or round holes in two different sizes.

Please note: tiles do not include light fixtures.

## FIXTURE OPTION EXAMPLES

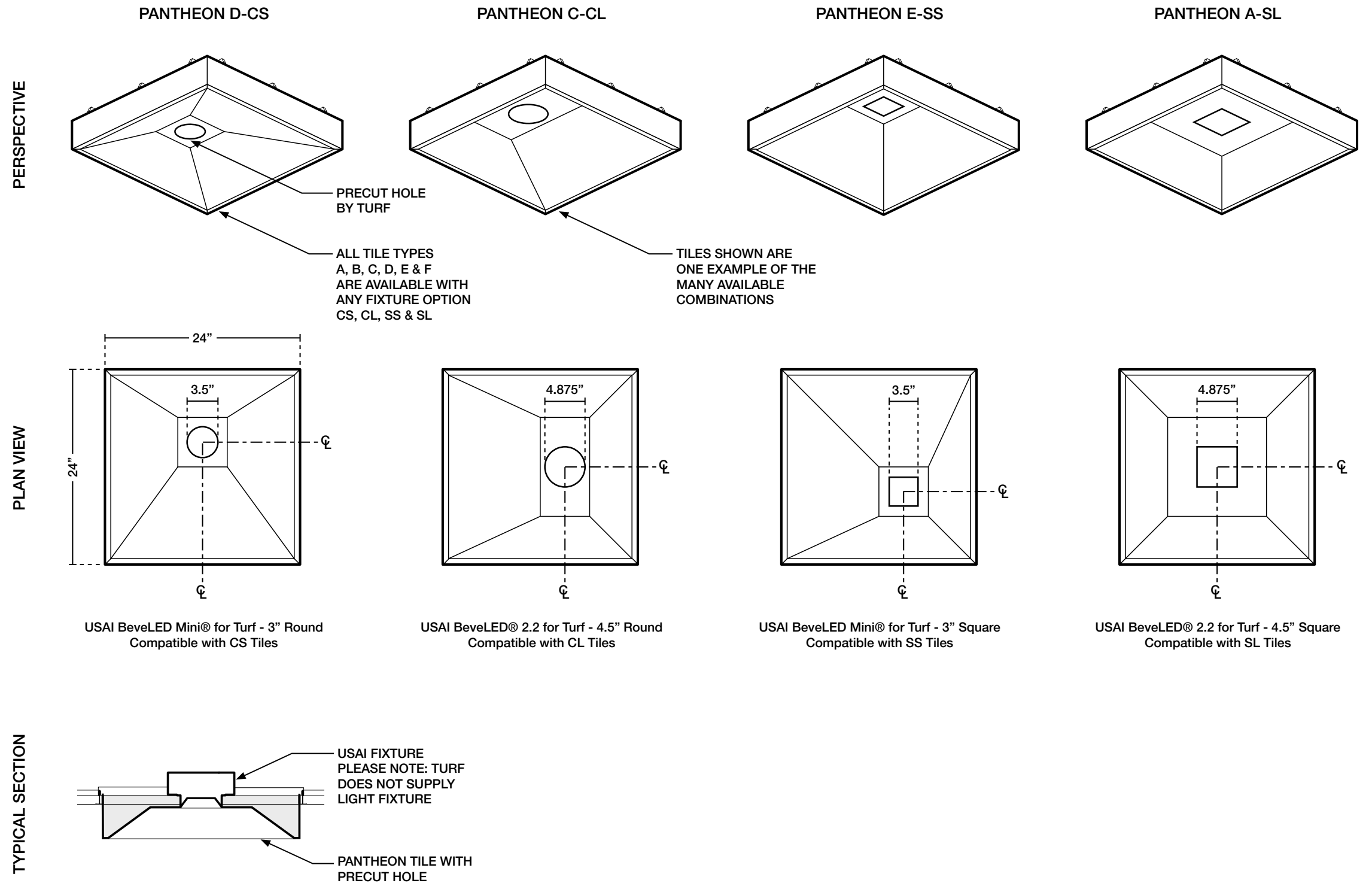

ALL DIMENSIONS NOMINAL UNLESS NOTED OTHERWISE



# Typical Layouts

Border

Using a variety of tile types, Pantheon can create a coffered look with a defined border around your space.

In-Line

Using only B or C tiles, this Pantheon layout can carve a path and give direction to any area.

**BORDER**

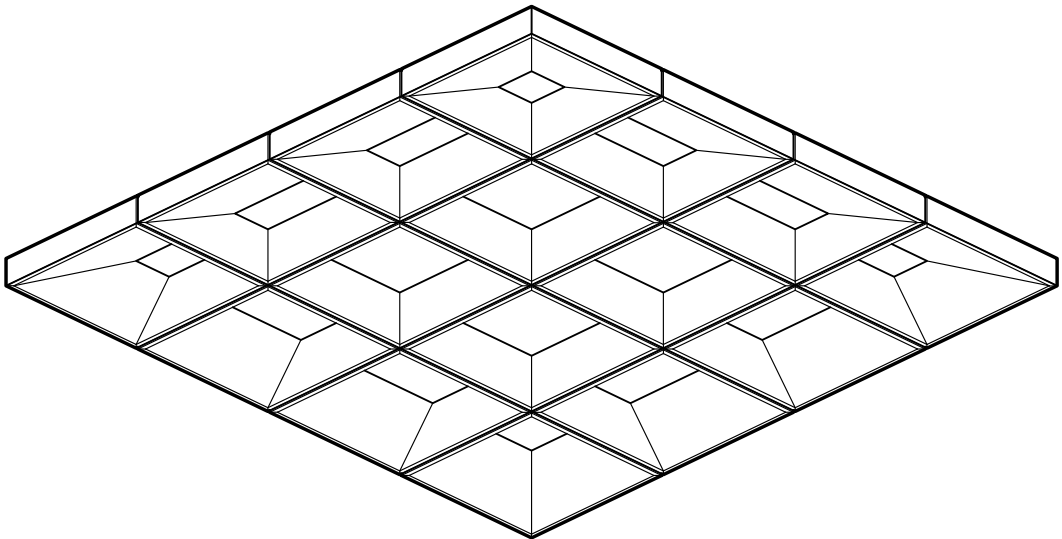

**IN-LINE**

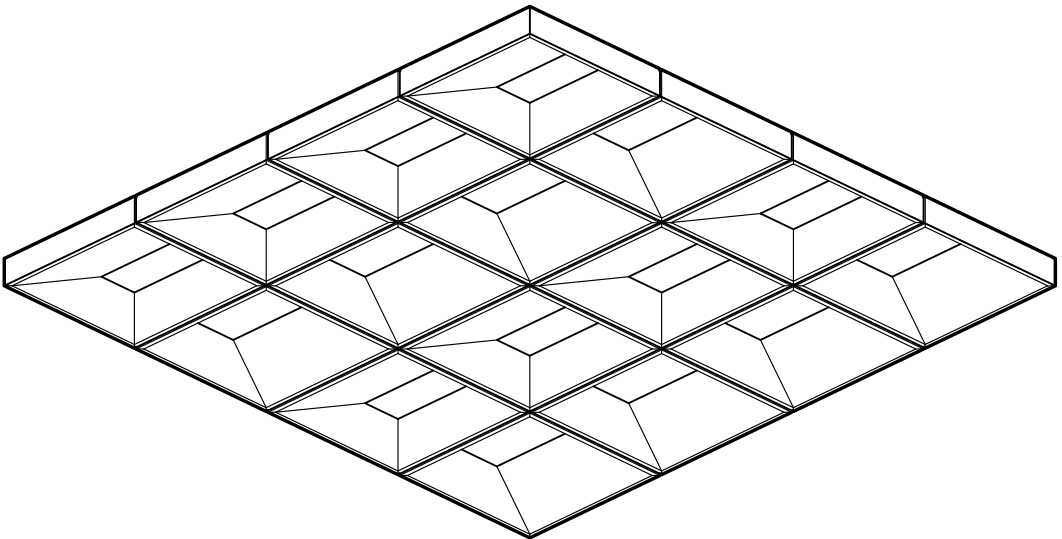

**BORDER PLAN VIEW**

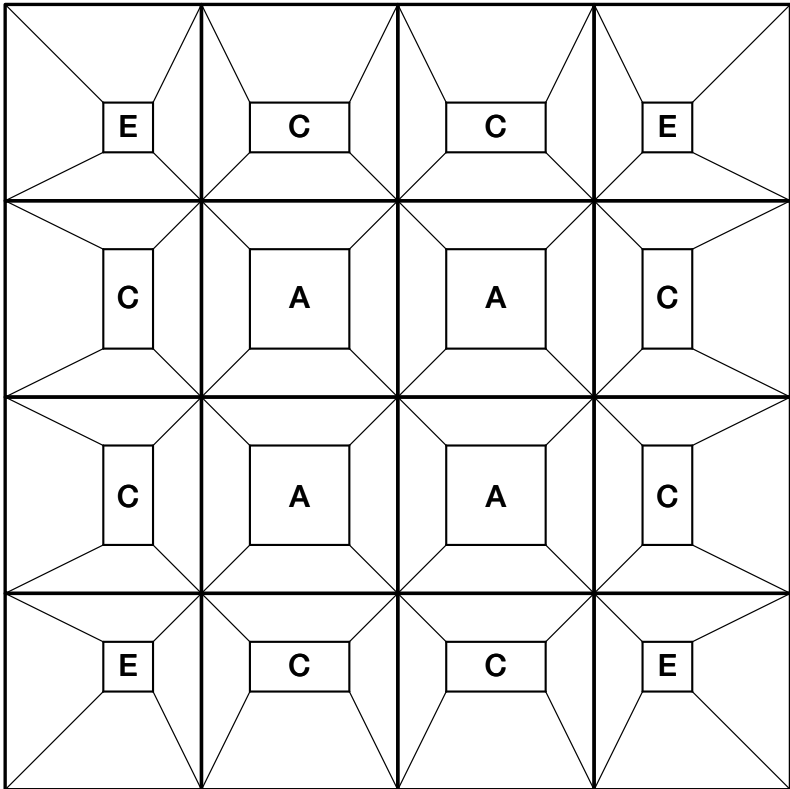

**IN-LINE PLAN VIEW**

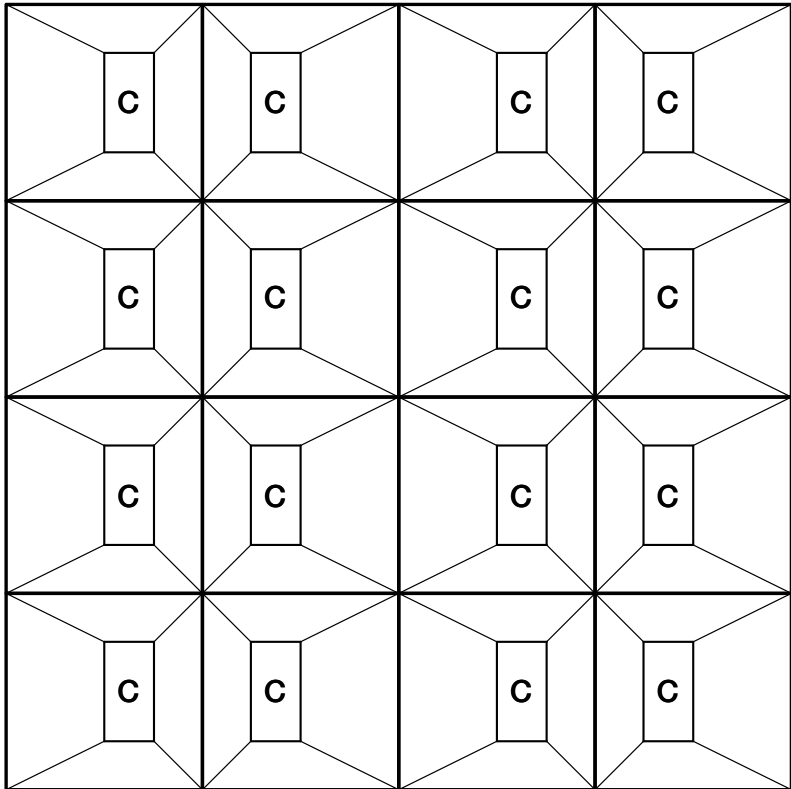

# Typical Layouts - Continued

Star

Take advantage of the shifted nature of Pantheon E tiles—create larger groupings and a star pattern.

STAR

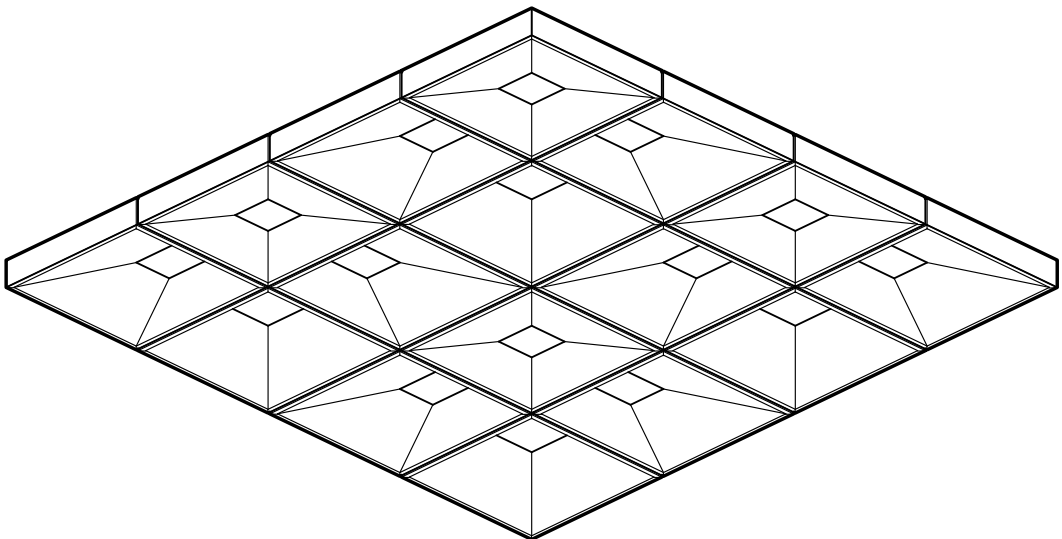

Open Checkerboard

Create a simple pattern alternating between Pantheon A & F tiles. Using Open tiles in this layout provides easy access to drop lighting or other ceiling equipment.

OPEN CHECKERBOARD

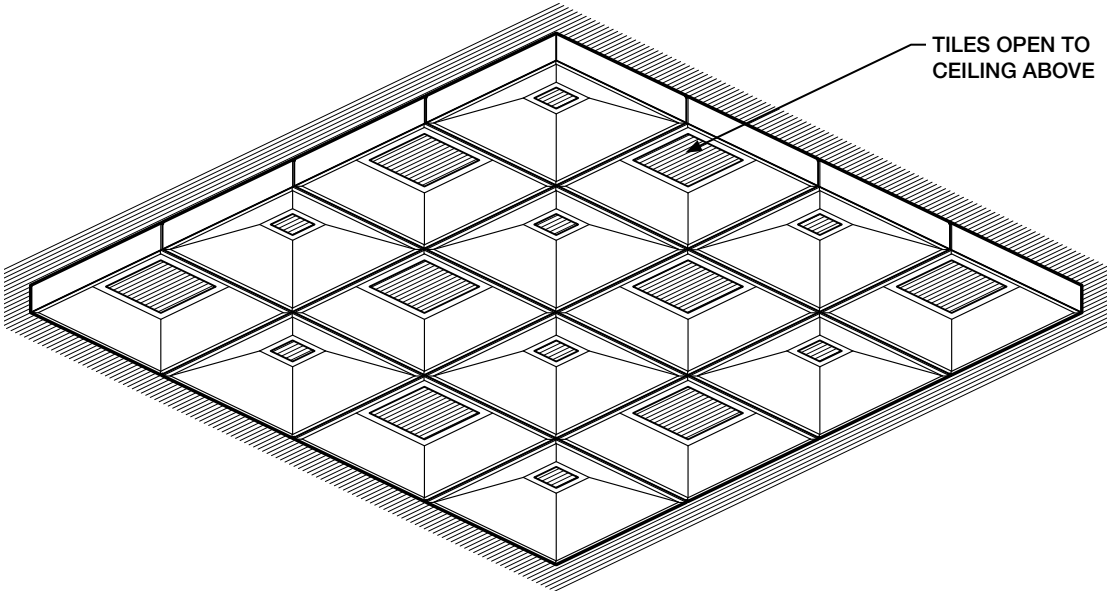

Unique Layout

The designs shown are only a handful of many possible configurations. Pantheon allows you to create a layout completely tailored to your space.

Every single tile type, open or closed, with or without lighting, can coordinate together.

STAR PLAN VIEW

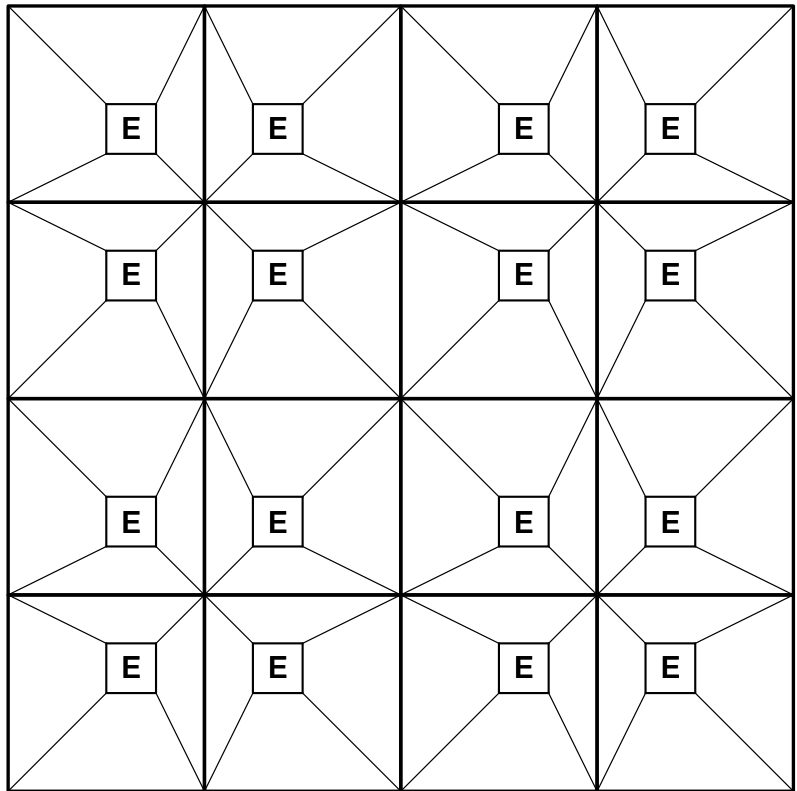

OPEN CHECKERBOARD PLAN VIEW

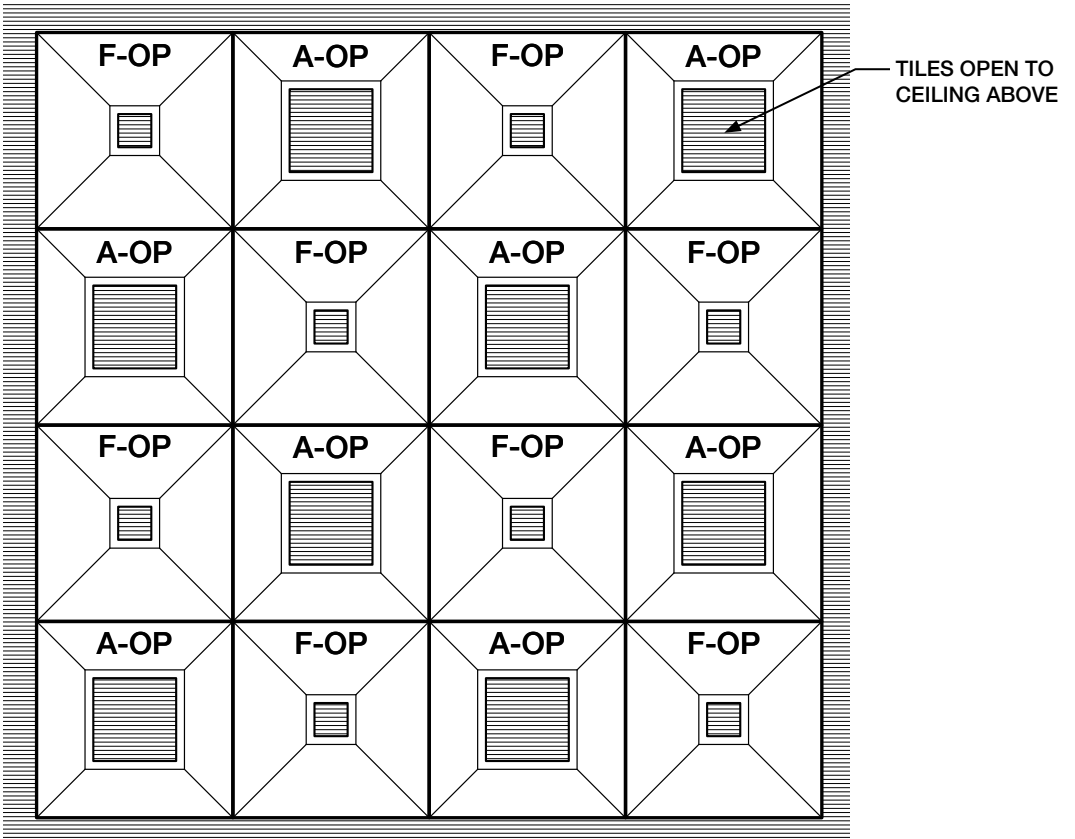

# Grains & Textures Pattern Direction

Wood Grains, Wood Textures & Travertine

All of Turf's Wood Grains, Wood Textures and any of the Travertine Stone Textures inherently have a pattern direction. Each individual tile can have the pattern running vertical or horizontal.

Client Specification

Work with the Turf Team to help define pattern direction within your layout.

Wood Grains, Wood Textures and Travertine Stone Textures are not available with Turf's Fast Track.

Direction Examples

ST01 Travertine is used as an example with Pantheon Tile C, and D04 Washed Ash is used as an example with Pantheon Tile E

Please note: all grains and textures are available for all tile types.

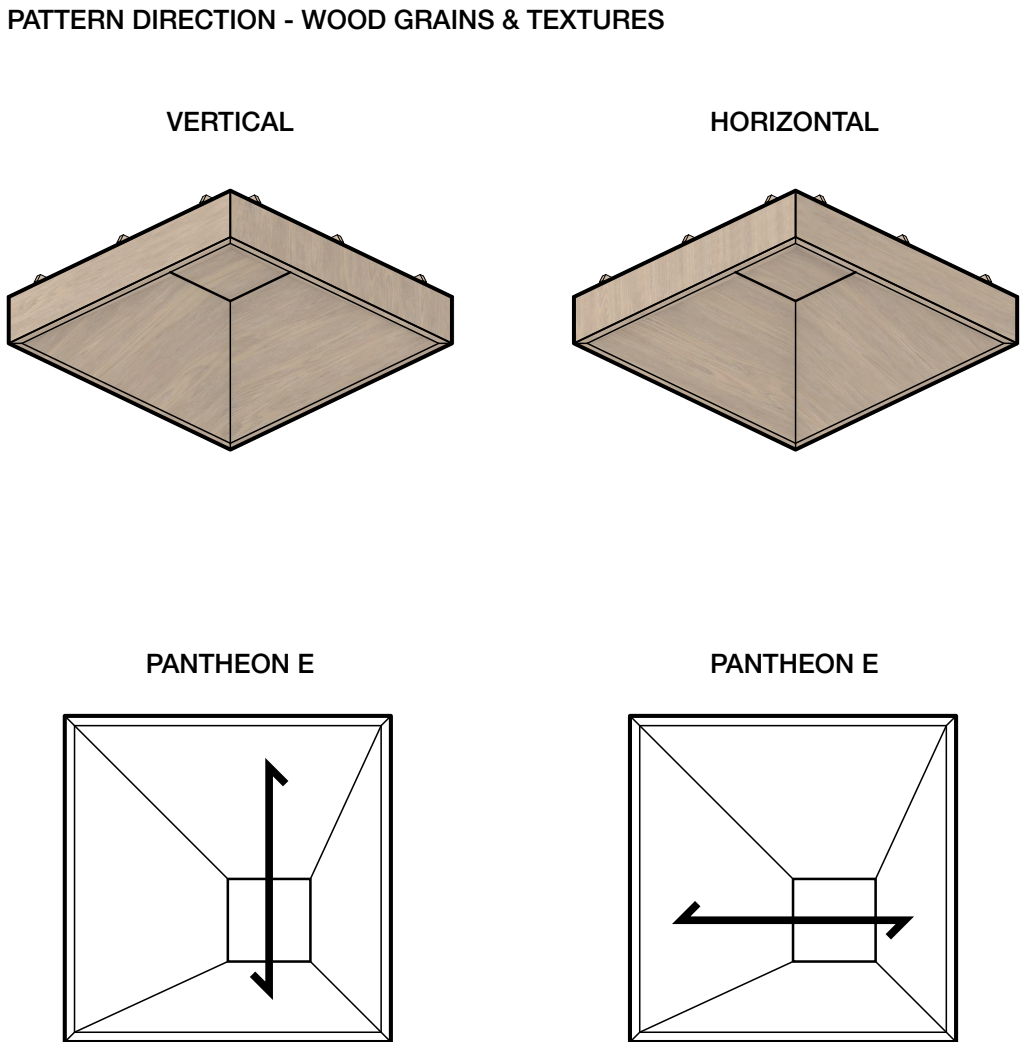
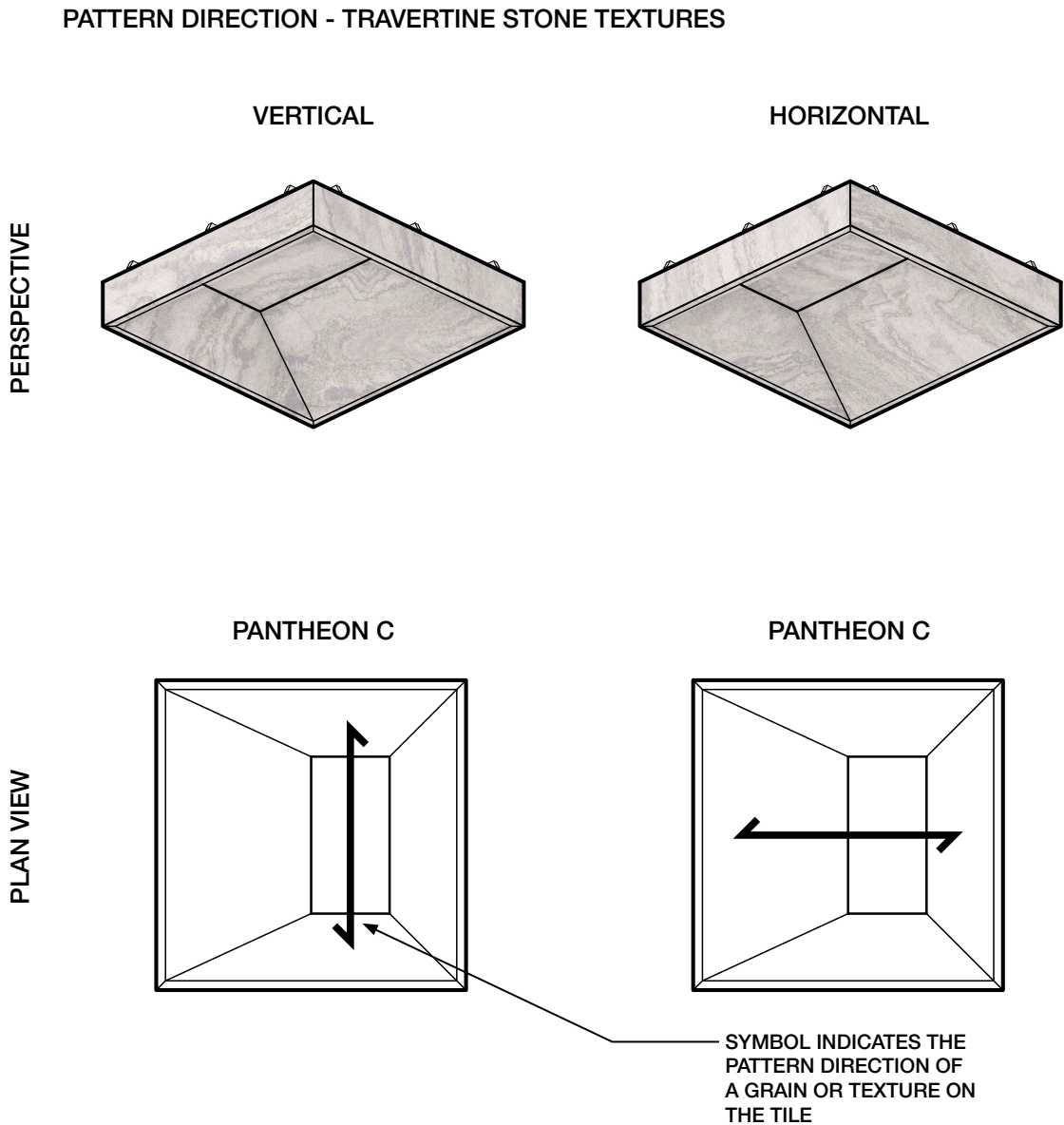

# Installation Guide

Pantheon tiles are designed for quick and easily installation into ceilings— just follow this simple guide.

## Tools Required

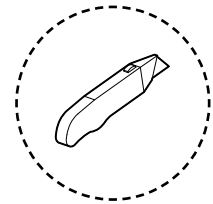

SHARP BLADE

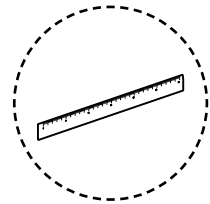

STRAIGHT EDGE

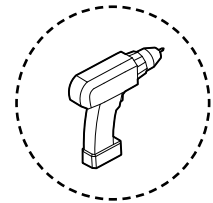

DRILL

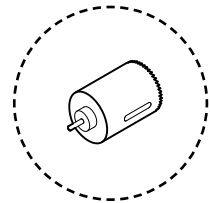

HOLE SAW

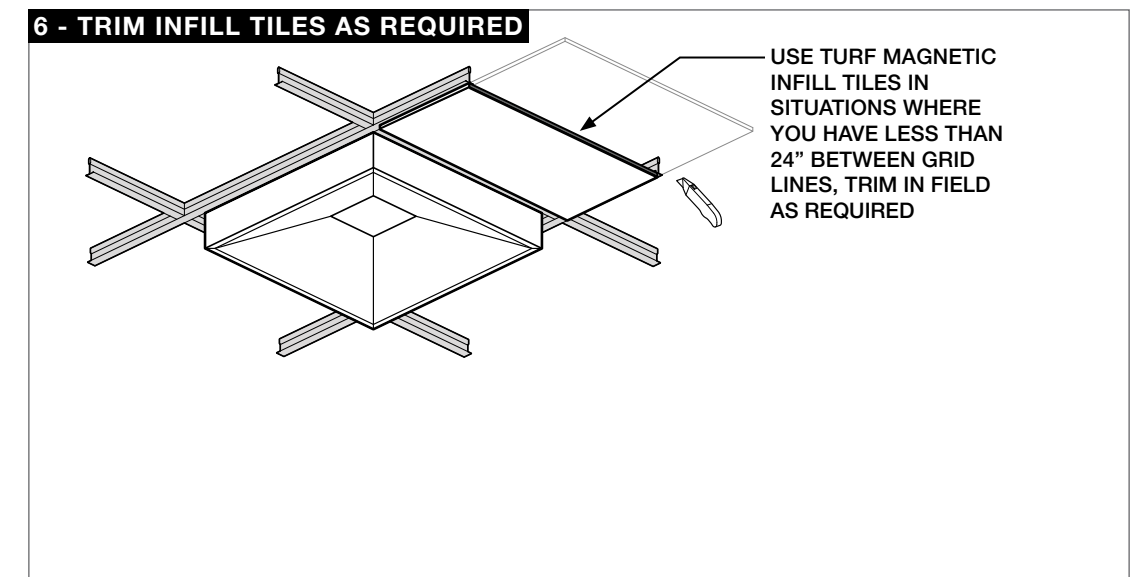
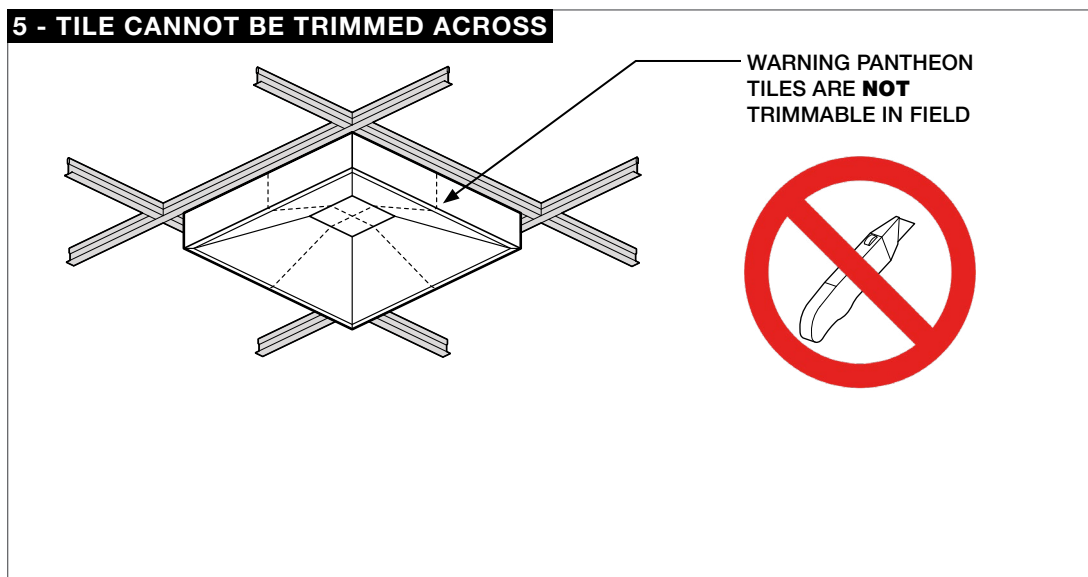
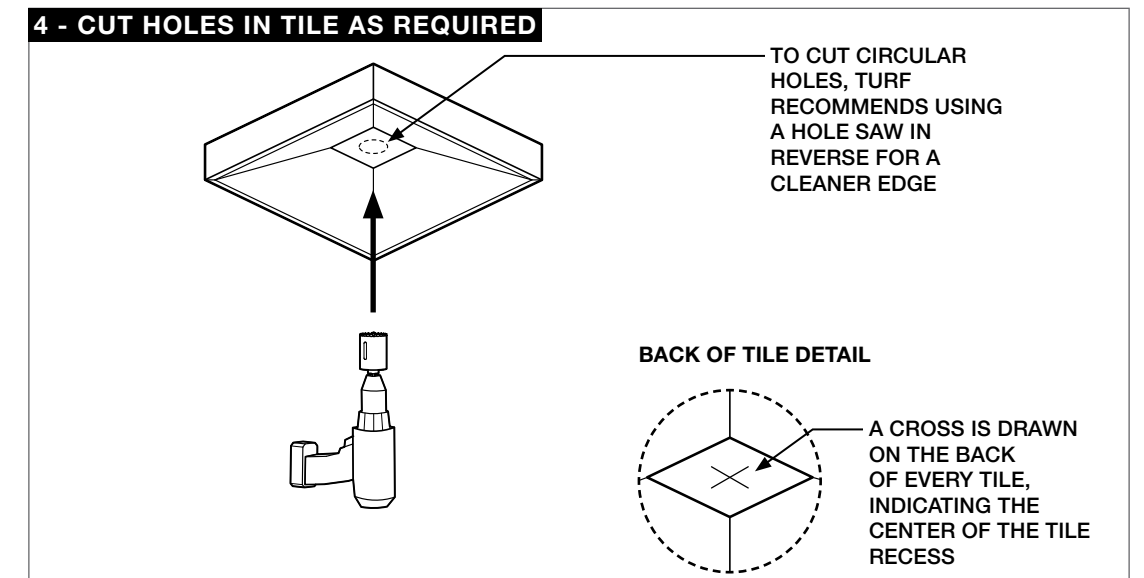
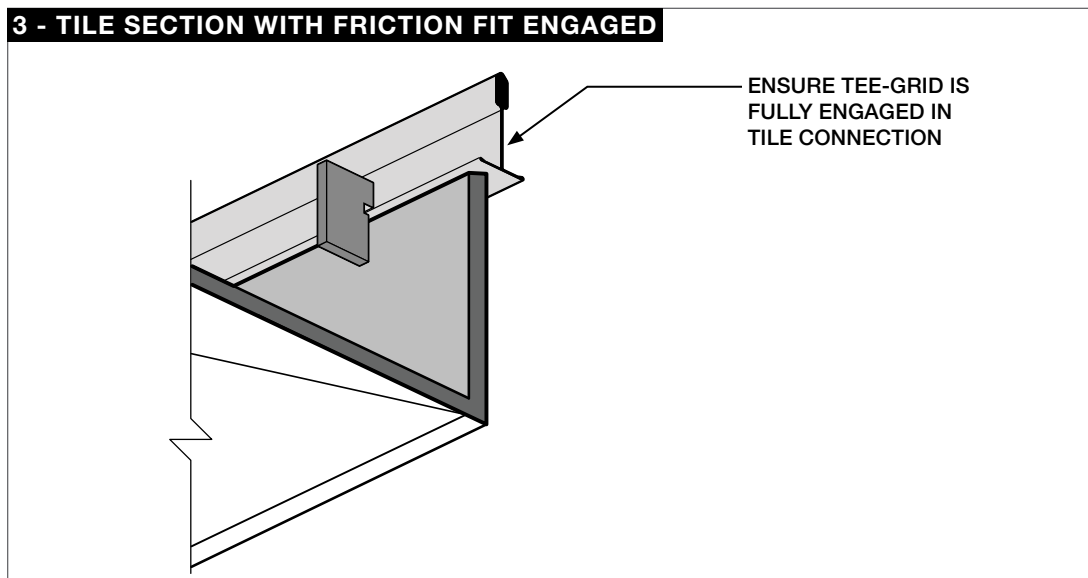
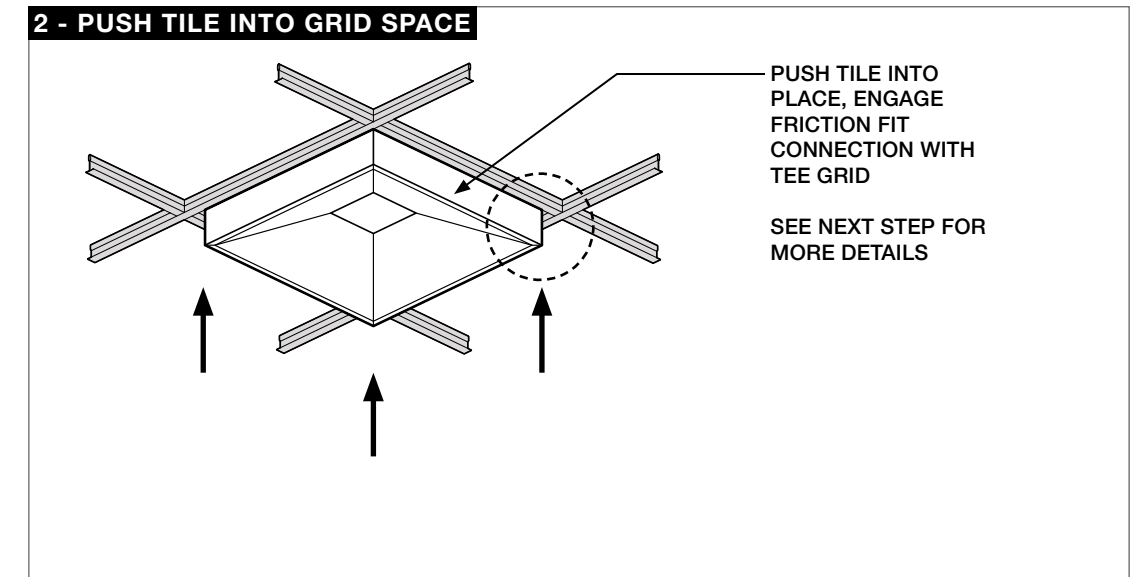
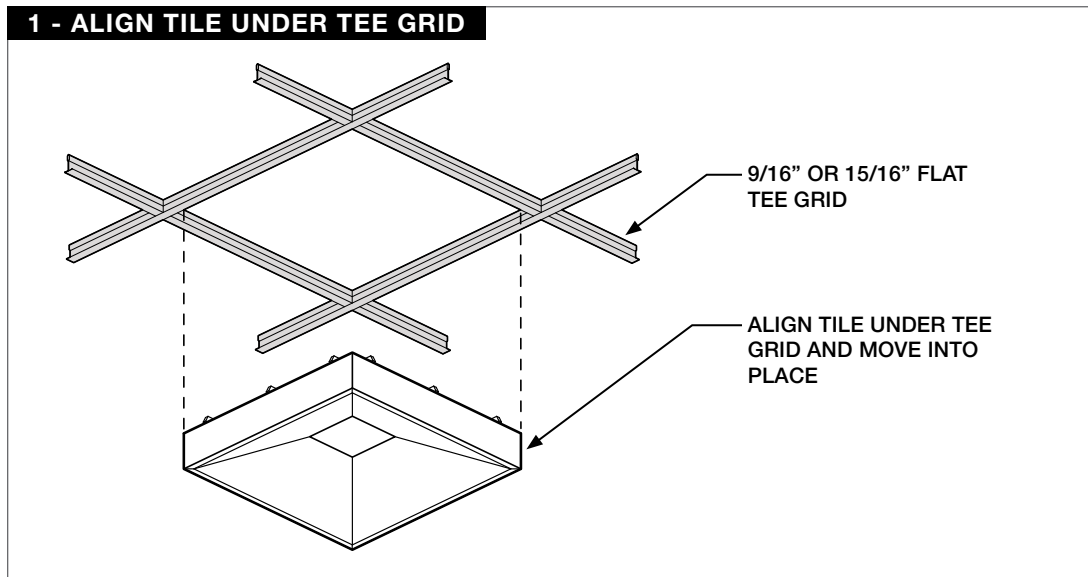

## Tech

Acoustics	ASTM C 423-17: E-400
Fire Rating	ASTM E-84 – Class A
VOC	ASTM D5116 Compliant

## Details

Lead Time	Check the Turf website for current lead times.
Warranty	Five (5) years
Maintenance	Vacuum to remove any particulate matter and air-borne debris or dust. Compressed air can be used to dust the material in difficult to reach areas for large assemblies. Contact us for more information relative to spot cleaning.
Weight	Turf products cannot support the weight of any other items in field.
Trademarks	Turf®, FeltLock™, GridLock™, T™ are trademarks of Turf Design, Inc. and/or its affiliates © 2025 Turf Design Inc. Printed in the United States of America

## Acoustic Rating

Pantheon Tile	NRC = 0.90
Pantheon Open Tile	NRC = 0.85

The ratings above describe an array of mixed ceiling tiles arranged in four rows of four units.

## Certifications

# Declare.



Image by Blaque Studio

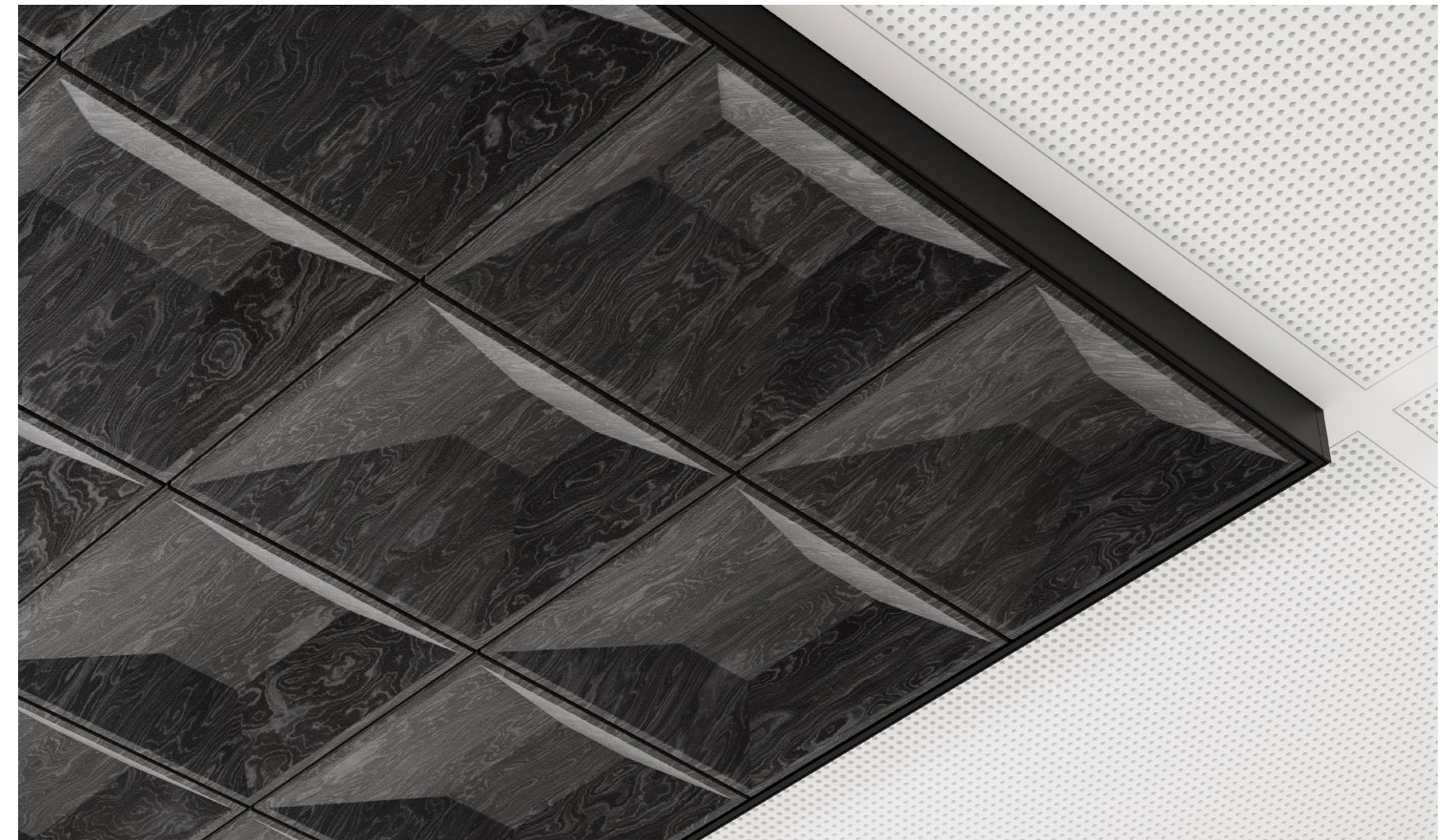

Image by Blaque Studio

# 9mm Colors

Introducing Hues, our new 9mm color palette designed for the senses.

The 9mm PET felt board is used as our primary construction material. Select one of our coordinating neutrals to blend in, or go for a contrasting element with one of our hues.

The process used to create PET felt often results in a heathered effect where multiple tones are present. Slight variations in color should be expected when using this sustainable material.

**Felt Thickness**  
9mm +/-0.5 mm

Monitors and printers vary. Please request a material sample to verify felt colors.



10 TOPO GREEN



12 GRASSHOPPER

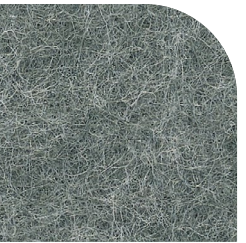

11 CELADON

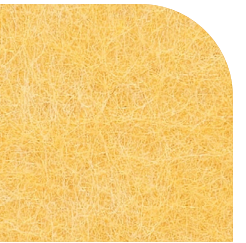

63 SAFFLOWER



64 PLANTAIN

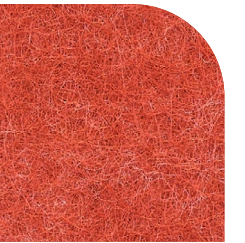

43 ORANGE CRUSH

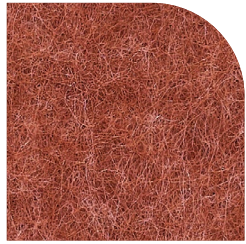

18 ULTISOL



17 BLUSH

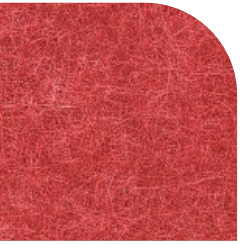

23 RED

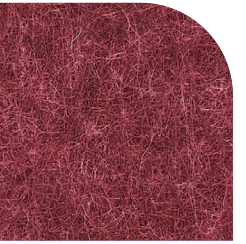

15 MERLOT

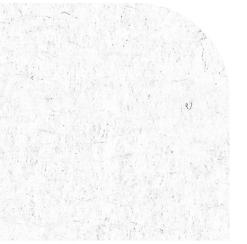

50 IVORY



33 LUMINARY



83 HOLLAND OATS



82 BARLEY



34 TONAL TAUPE



35 BARK

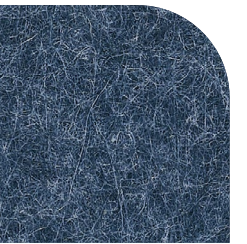

28 INDIGO

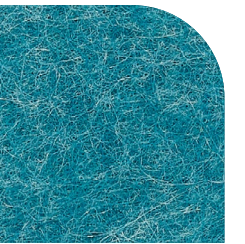

30 CYAN

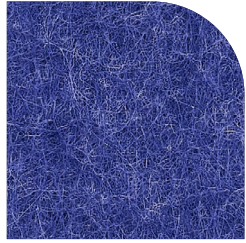

24 ROYAL BLUE

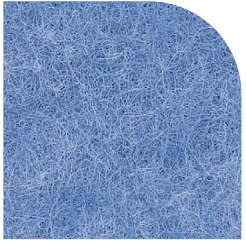

31 AZURE

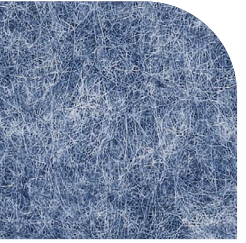

27 JEAN JACKET

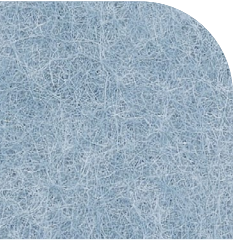

26 FADED DENIM

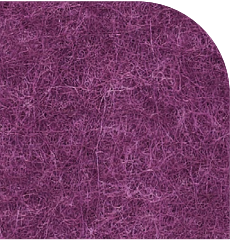

40 MAGENTA

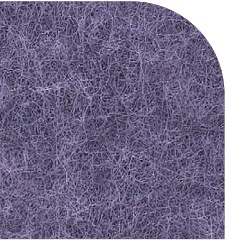

41 DRIED LAVENDER

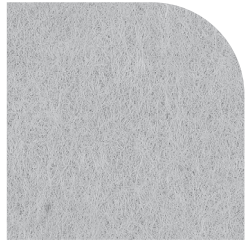

66 PEWTER



05 WHITE

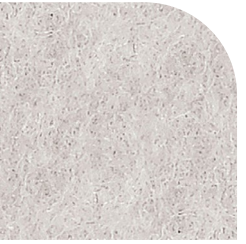

01 CREAM

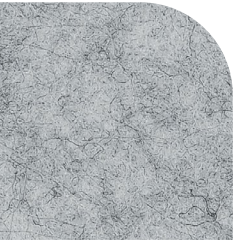

04 LIGHT GREY



98 STORM

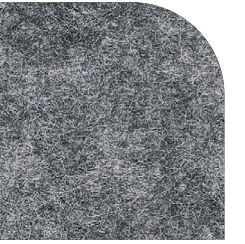

09 DAMASCUS

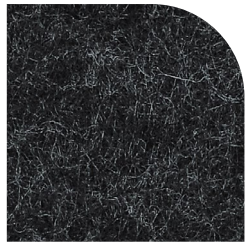

06 CHARCOAL



07 BLACK



# 9mm Wood Grains

Invite nature into your space with our wood-inspired grains. Digital printing on felt ensures a unique and realistic grain with virtually no repeats.

There is an additional product cost for Wood Grains.

Please note there is additional lead time for custom matching. Grain customization will incur additional costs beyond our standard 9mm options.

**Felt Thickness**  
9mm +/-0.5 mm

**Monitors and printers vary.**  
Please request a material sample to verify felt colors.



D01 WHITE ASH



D02 SILVER TEAK



D03 CLEAR MAPLE



D04 WASHED ASH



D05 MEDIUM OAK



D06 PLANKED OAK

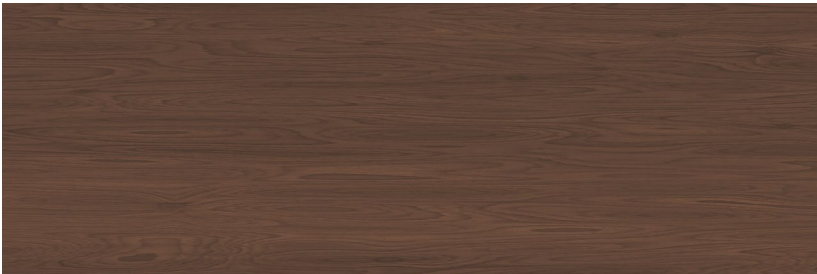

D07 DARK WALNUT



D08 BLACK PEAR

## 9mm Wood Textures

Designed for those who go against the grain. Our digitally printed Wood Textures are inspired by wood veneer cuts and are designed to work with all 32 of our Hues. Flat, Rift and Rotary each represent a unique aesthetic that gives you range in your designs.

There is an additional product cost for Wood Textures.

**Felt Thickness**  
9mm +/-0.5 mm

## Visualization

Our Wood Textures are available on all of our 32 Hues. Select a texture and felt color, and let Turf do the rest. Please visit the Turf website for more examples and visualizations.

[turf.design/colors](https://turf.design/colors)

07 Black is the only substrate color that uses white ink when printing the texture.

Monitors and printers vary. Please request a material sample to verify felt colors.

## How To Specify

### Select Color Number

Choose from the entire 9mm color line

W T 0 0

### Select Texture Name

Flat  
Rift  
Rotary

X X X X X X

WOOD TEXTURE

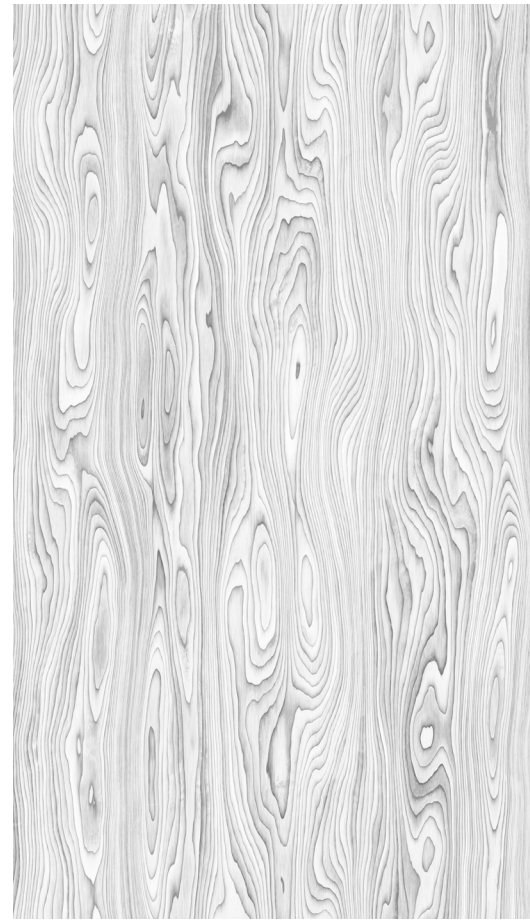

FLAT

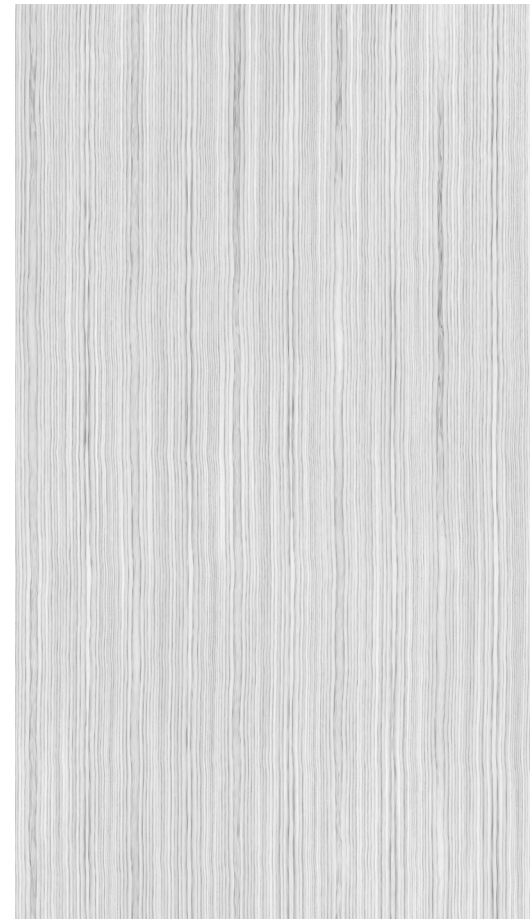

RIFT

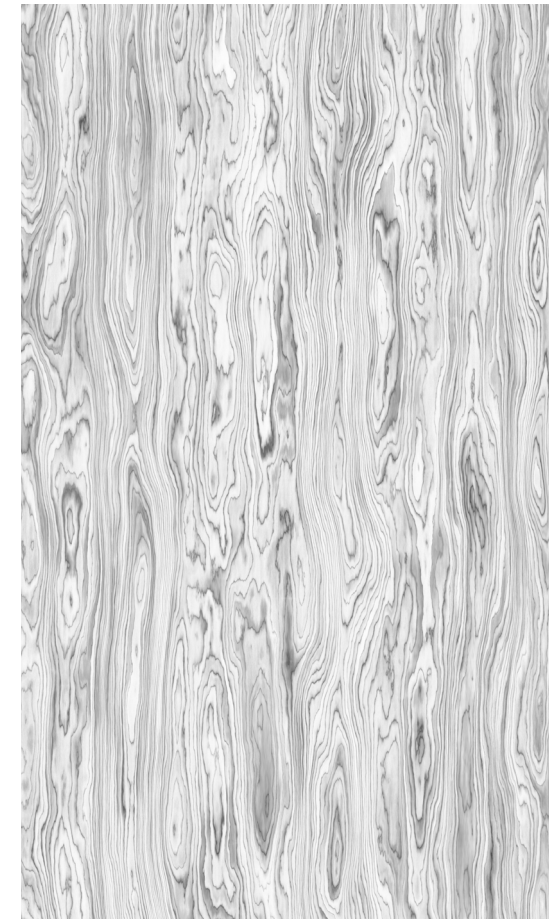

ROTARY

ALL COLORS AVAILABLE

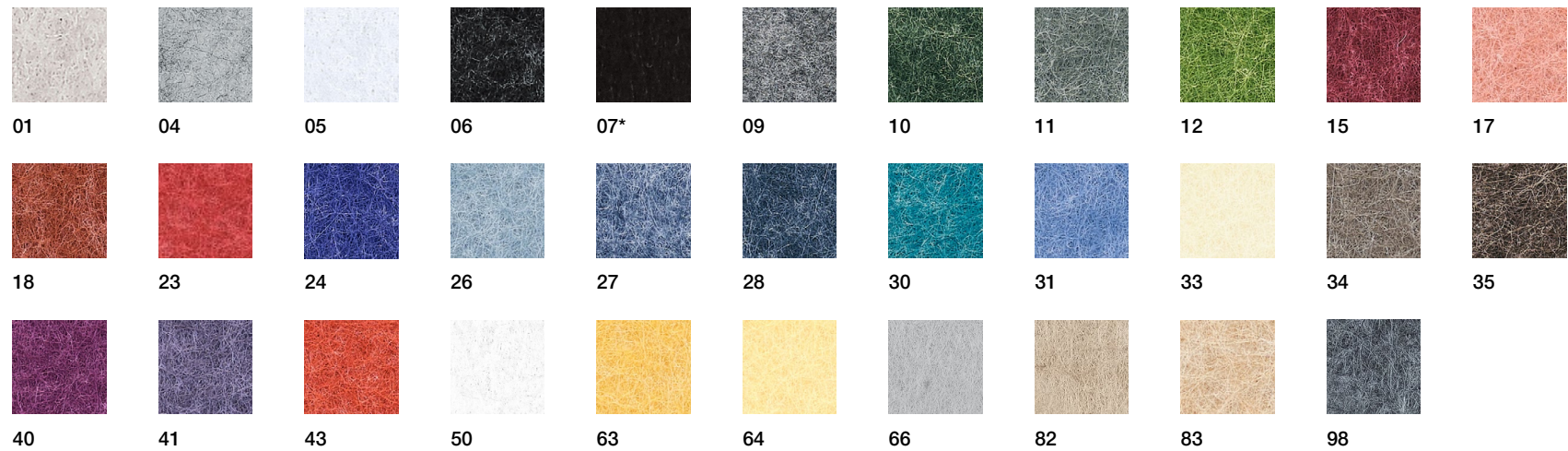

\* 07 Black is the only substrate color that uses white ink when printing the texture

## 9mm Stone Textures

Inspired by nature, designed for felt. Our digitally printed Stone Textures capture the character and nuance of stone on top of a curated color collection from our Hues palette with virtually no repeats. The three patterns in this family capture unique elements from the stones for which they are named.

There is an additional product cost for Stone Textures.

Turf has curated this collection to include only the best pattern and color combinations.

**Felt Thickness**  
9mm +/-0.5 mm

## Visualization

Our Stone Textures are available on a curated portion of the Hues collection. Select a texture and felt color, and let Turf do the rest. Please visit the Turf website for more examples and visualizations.

[turf.design/colors](https://turf.design/colors)

Monitors and printers vary. Please request a material sample to verify felt colors.

## How To Specify

### Select Color Number

Choose from the available color list

S T 0 0

### Select Texture Name

Travertine  
Granite  
Marble

X X X X X X X X X X X

STONE TEXTURE



TRAVERTINE



GRANITE

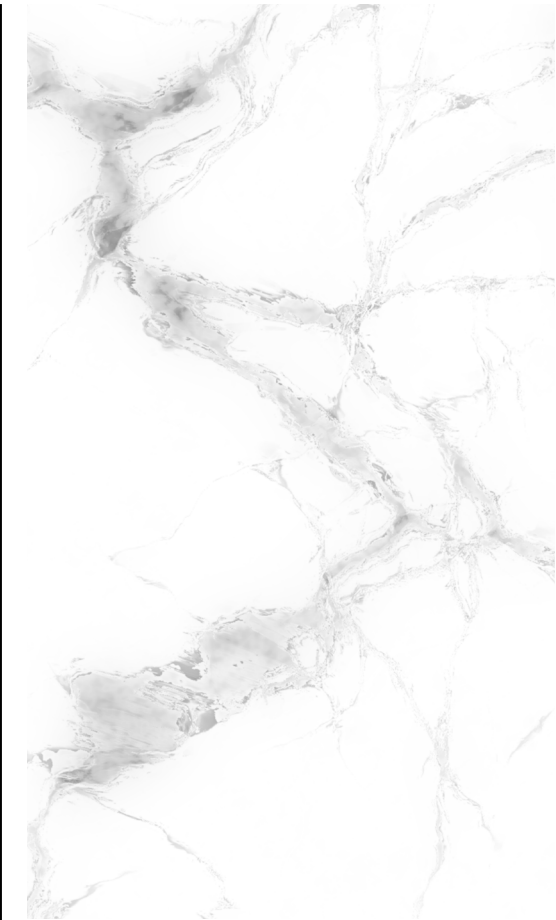

MARBLE

AVAILABLE COLORS

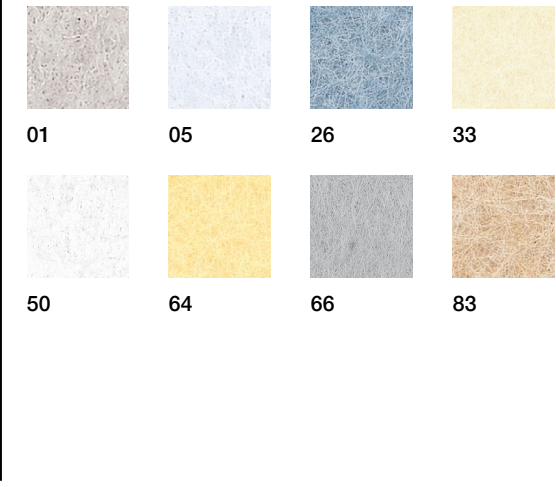
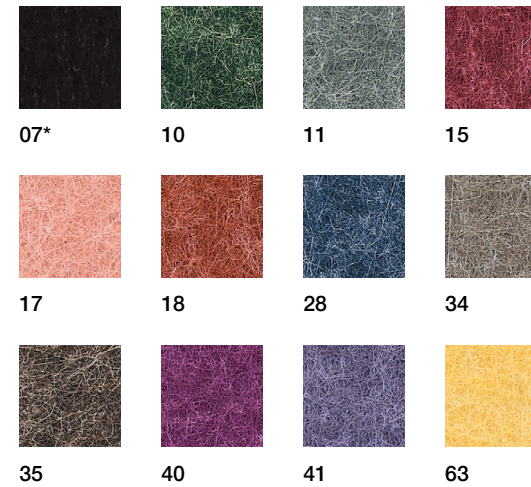
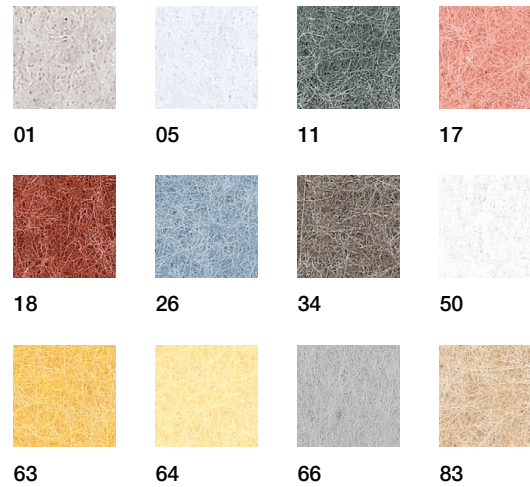

\* 07 Black is the only substrate color that uses white ink when printing the texture